

# Essentials Collection

DOOR STYLE SELECTIONS





Home is our place for rest and comfort, for joy and memories. As we tailor our homes to suit the needs of our families, they become a reflection of who we are.

Because cabinetry is such an integral part of our homes, Bishop Cabinets makes each cabinet to order so that you can structure your living spaces to best suit your particular needs. But cabinetry is about more than just structure, it is also about beauty. The combinations of wood species, door styles and finishes that you will find within these pages will give you literally hundreds of thousands of possibilities, so that you can create that fashion which perfectly defines you.

In this booklet you'll find door styles from our Essentials Collection, which offers pre-designed door styles in many of today's most popular combinations.

The images shown on the following pages are only a small taste of those possibilities. After you've spent some time pondering what you might like, we invite you to visit your Bishop dealer to select your perfect style.

# Birch

## York

Slab



Wood Specie  
Birch  
Overlay  
Full  
Finish Shown  
Pinot Noir stain  
Doors  
Square uppers  
Square lowers  
2" Stiles  
Drawer Fronts  
Slab shallow  
Slab deep

Recessed Panel Square upper & lower doors  
Available for Framed and Full Access Cabinetry

## Petersburg

5 Piece



Wood Specie  
Birch  
Overlay  
Full  
Finish Shown  
Light stain  
Doors  
Square uppers  
Square lowers  
2" Stiles  
Drawer Fronts  
5 Piece shallow  
5 Piece deep

Recessed Panel Square upper & lower doors  
Available for Framed and Full Access Cabinetry

## Zermatt

Slab



Wood Specie  
Birch  
Overlay  
Full  
Finish Shown  
Iron Paint  
Doors  
Square uppers  
Square lowers  
3" Stiles  
Drawer Fronts  
Slab shallow  
Slab deep

Recessed Panel Square upper & lower doors  
Available for Framed and Full Access Cabinetry

## Utica

5 Piece



Wood Specie  
Birch  
Overlay  
Full  
Finish Shown  
Offwhite base  
coat with  
Mocha glaze  
Doors  
Square uppers  
Square lowers  
3" Stiles  
Drawer Fronts  
5 Piece shallow  
5 Piece deep

Recessed Panel Square upper & lower doors  
Available for Framed and Full Access Cabinetry

# Birch

## Dallas

Slab



Wood Specie  
Birch  
Overlay  
Full  
Finish Shown  
Natural finish  
Doors  
Veneer Slab uppers  
Veneer Slab lowers  
Drawer Fronts  
Veneer Slab shallow  
Veneer Slab deep

Slab upper & lower doors

Available for Framed and Full Access Cabinetry

## Soho

Slab

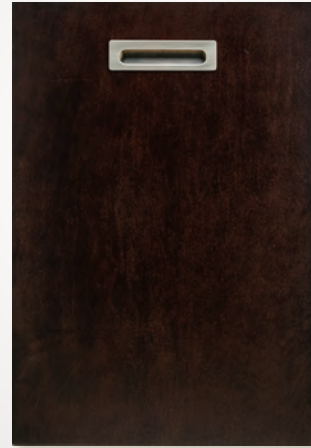
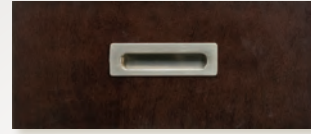

Wood Specie  
Birch  
Overlay  
Full  
Finish Shown  
Espresso stain  
Doors  
Veneer Slab uppers  
Veneer Slab lowers  
Drawer Fronts  
Veneer Slab shallow  
Veneer Slab deep  
Includes integrated  
pulls as shown

Slab upper & lower doors

Available for Framed and Full Access Cabinetry

## Norfolk

Slab



Wood Specie  
Birch  
Overlay  
1/2"  
Finish Shown  
Amber stain  
Doors  
Square uppers  
Square lowers  
2" Stiles  
Drawer Fronts  
Slab shallow  
Slab deep  
Veneer center  
panels

Raised Panel Square upper & lower doors

Available for Framed Cabinetry

## Springfield

Slab



Wood Specie  
Birch  
Overlay  
1/2"  
Finish Shown  
Chestnut stain  
Doors  
Square uppers  
Square lowers  
2" Stiles  
Drawer Fronts  
Slab shallow  
Slab deep

Recessed Panel Square upper & lower doors

Available for Framed Cabinetry

# Birch

## Lauderdale

5 Piece



Wood Specie  
Birch  
Overlay  
Full  
Finish Shown  
Light stain with  
Chocolate glaze  
Doors  
Square uppers  
Square lowers  
2 1/4" Stiles  
Drawer Fronts  
5 piece shallow  
5 piece deep

Recessed Panel Square upper & lower doors  
*Available for Framed Cabinetry*

## Charleston

Slab



Wood Specie  
Birch  
Overlay  
Full  
Finish Shown  
Obsidian stain  
Doors  
Square uppers  
Square lowers  
2 1/4" Stiles  
Drawer Fronts  
Slab shallow  
Slab deep

Recessed Panel Square upper & lower doors  
*Available for Framed Cabinetry*



*Danbury door style in Maple with Brilliant White paint  
Image compliments of Main Line Kitchen Design*

# Birch

## Greenbriar

5 Piece



Wood Specie  
Birch  
Overlay  
Full  
Finish Shown  
Nordic White  
base coat with  
Mocha glaze  
Doors  
Square uppers  
Square lowers  
2" Stiles  
Drawer Fronts  
5 Piece shallow  
5 Piece deep  
Veneer center  
panels

Raised Panel Square upper & lower doors  
Available for Framed Cabinetry

## Fargo

Slab

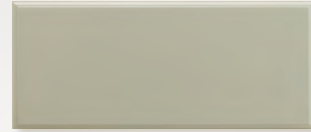

Wood Specie  
Birch  
Overlay  
Full  
Finish Shown  
Ellie Gray Paint  
Doors  
Square uppers  
Square lowers  
2" Stiles  
Drawer Fronts  
Slab shallow  
Slab deep  
Veneer center  
panels

Raised Panel Square upper & lower doors  
Available for Framed Cabinetry

## Asheville

5 Piece



Wood Specie  
Birch  
Overlay  
Full  
Finish Shown  
Custom paint color  
Doors  
Square uppers  
Square lowers  
2 1/4" Stiles  
Drawer Fronts  
5 Piece shallow  
5 Piece deep  
Veneer center  
panels

Raised Panel Square upper & lower doors  
Available for Framed Cabinetry

## Rutland

Slab



Wood Specie  
Birch  
Overlay  
Full  
Finish Shown  
Natural finish  
Doors  
Square uppers  
Square lowers  
2 1/4" Stiles  
Drawer Fronts  
Slab shallow  
Slab deep  
Veneer center  
panels

Raised Panel Square upper & lower doors  
Available for Framed Cabinetry

# Paint Grade

## Juneau

5 Piece



Wood Specie  
Maple Frames  
MDF panels  
Overlay  
Full  
Finish Shown  
Putty paint  
Doors  
Square uppers  
Square lowers  
2 1/2" Stiles  
Drawer Fronts  
5 Piece shallow  
5 Piece deep

Recessed Panel Square upper & lower doors  
Available for Framed and Full Access Cabinetry

## Kirkwood

Slab

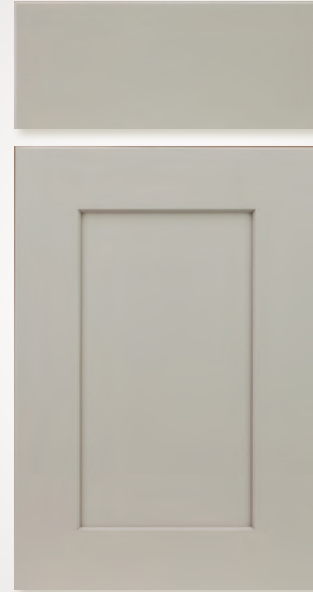

Wood Specie  
Maple Frames  
MDF panels  
Overlay  
Full  
Finish Shown  
Ellie Grey Paint  
Doors  
Square uppers  
Square lowers  
2 1/2" Stiles  
Drawer Fronts  
Slab shallow  
Slab deep

Recessed Panel Square upper & lower doors  
Available for Framed and Full Access Cabinetry



Danbury door style with Custom White Paint  
Image compliments Hamby's Kitchen Center

# Maple

## Bridgehaven

5 Piece



Wood Specie  
Maple  
Overlay  
Full  
Finish Shown  
Chalk base coat  
with Oyster glaze  
Doors  
Square uppers  
Square lowers  
2 1/4" Stiles  
Drawer Fronts  
5 Piece shallow  
5 Piece deep

Raised Panel Square upper & lower doors  
*Available for Framed Cabinetry*

## Martinique

Slab



Wood Specie  
Maple  
Overlay  
Full  
Finish Shown  
Pinot Noir stain  
Doors  
Square uppers  
Square lowers  
2 1/4" Stiles  
Drawer Fronts  
Slab shallow  
Slab deep

Raised Panel Square upper & lower doors  
*Available for Framed Cabinetry*

## Danbury

5 Piece



Wood Specie  
Maple  
Overlay  
Full  
Finish Shown  
Chestnut stain  
Doors  
Square uppers  
Square lowers  
2 1/8" Stiles  
Drawer Fronts  
5 Piece shallow  
5 Piece deep

Reversed Raised Panel Square upper & lower doors  
*Available for Framed Cabinetry*

## Quakerstown

Slab

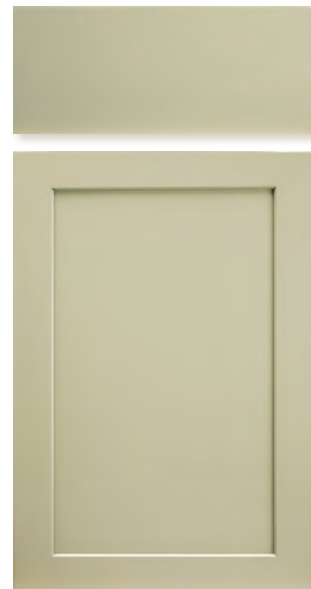

Wood Specie  
Maple  
Overlay  
Full  
Finish Shown  
Custom paint  
Doors  
Square uppers  
Square lowers  
2 1/8" Stiles  
Drawer Fronts  
Slab shallow  
Slab deep

Reversed Raised Panel Square upper & lower doors  
*Available for Framed Cabinetry*



# Maple

# Oak

## Thomaston

5 Piece



Wood Specie  
Maple

Overlay  
Full

Finish Shown  
Natural finish

Doors  
Square uppers  
Square lowers  
2 1/8" Stiles

Drawer Fronts  
5 Piece shallow  
5 Piece deep

Reverse Raised Panel Square upper & lower doors with Center Battens applied to wider doors

Available for Framed Cabinetry

## Essex

Slab

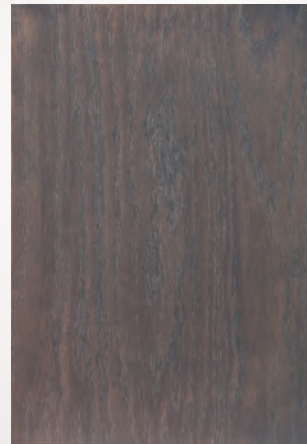
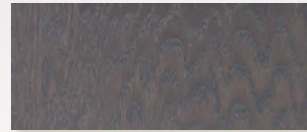

Wood Specie  
Oak Veneer

Overlay  
Full

Finish Shown  
Dusk Stain

Doors  
Slab uppers  
Slab lowers

Drawer Fronts  
Slab shallow  
Slab deep

Slab upper & lower doors

Available for Framed and Full Access Cabinetry



Petersburg door style mixing paint with stain  
Image courtesy of Oreid Design

# Endless Choices

Our Essentials collection consists of Hard Maple, Birch, and Oak wood species. Each species contains many distinguishing characteristics that affect its overall beauty and final finished look. During the planning stages of your new kitchen, it is vitally important to review exact samples of the wood and finish combinations you are considering. The unique characteristics of these species will cause the same applied finishes and techniques to be beautifully different in many ways.

Depending on your desired delivery date, we have many options for you to choose from when it comes to finish. We offer standard stains, paints, and specialty techniques in a standard lead-time. Or, if your project has more flexibility in time and your desired finishes are custom, we have endless choices available in our custom paint, custom stain, and non-standard finish programs. Please consult with your dealer during the planning phase of your project for a full explanation of our lead times, available finishes, and door style options.



*Utica door style with two paint colors  
Image courtesy of Main Line Kitchen Design*

# Wood Finishes

## Samples of Stains, Base Coats and Paints

These samples are only a small example of the thousands of paints, stains and base coats available. See your Bishop dealer for more!

*\*See page 10 for custom finish options.*



Driftwood stain on Oak



Medium stain on Cherry



Light stain on Maple



Dusk stain on Maple



Fog stain on Maple



Natural finish on Maple



Medium stain on Oak



Obsidian stain on Cherry



Natural finish on Birch



Obsidian stain on Birch



\*Custom base coat on Maple

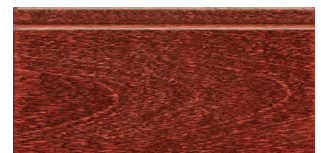

Pinot Noir stain on Birch



Dusk stain on Cherry



Nordic White paint on Maple



Light stain on Cherry



\*Custom base coat on Maple



Black paint on Maple



Fog stain on Oak



Driftwood stain on Cherry



Amber stain on Maple



Chestnut stain on Birch



\*Custom base coat on Maple



Offwhite base coat on Maple



\*Custom base coat on Maple

# Wood Finishes

## Hand-Applied Finish Techniques

Add any combination of these techniques to stains or base coats to create one-of-a-kind Old World finishes!



Glaze (chocolate)  
Shown on Offwhite base coat



Edgewear  
Shown on Black base coat



Physical Distress  
Shown on Brilliant White  
base coat with Oyster glaze

## Samples of Glazed Finishes



Light stain w/  
Black glaze on  
Cherry



Custom base coat  
w/ Chocolate  
glaze on Maple



Pinot Noir stain  
w/ Black glaze  
on Oak



Custom base coat  
w/ Chocolate  
glaze on Maple



Natural finish  
w/ Black glaze  
on Oak

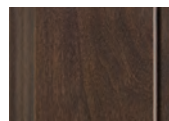

Obsidian stain w/  
Chocolate glaze  
on Cherry

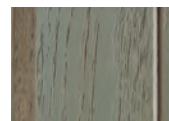

Custom base coat  
w/ Chocolate  
glaze on Oak



Custom base coat  
w/ Oyster glaze  
on Maple



Natural finish w/  
Oyster glaze on  
Cherry

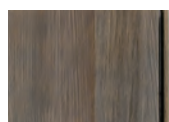

Driftwood stain  
w/ Black glaze  
on Cherry



Medium stain  
w/ Mocha glaze  
on Cherry

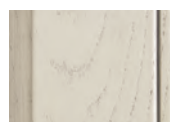

Offwhite base  
coat w/ Oyster  
glaze on Oak



Cinnamon stain  
w/ Black glaze  
on Cherry

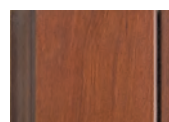

Custom stain  
w/ Black glaze  
on Cherry



Custom base coat  
w/ Mocha glaze  
on Oak



Light stain w/  
Mocha glaze on  
Maple



Offwhite base coat  
w/ Chocolate  
glaze on Maple

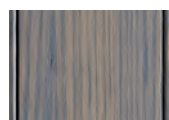

Driftwood stain  
w/ Black glaze on  
Oak



Pinot Noir stain  
w/ Black glaze  
on Cherry



Iron base coat w/  
Black glaze on  
Maple



Amber stain w/  
Chocolate glaze  
on Maple

## Custom Paints and Stains

Have you found a stain or paint color that you just can't live without? Our Custom Finish program may be just what you are looking for!

Your Bishop dealer can send a paint color number or a physical sample of the color to us and we will match it.



# Melamine Door Styles

## Elegante

Slab

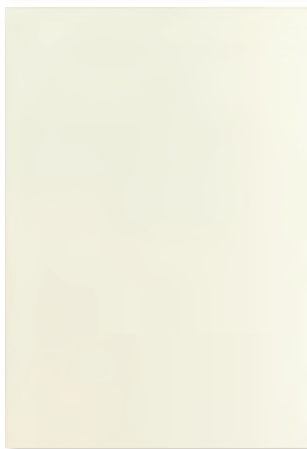
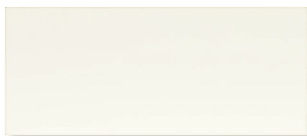

Laminate  
High Gloss  
Melamine  
Color  
Blanco  
Doors  
Slab Uppers  
Slab Loweres  
Drawer Fronts  
Slab Shallow  
Slab Deep

Slab Upper & Lower Doors

Available for Full Access Cabinetry

## Yosemite

Slab



Laminate  
Textured  
Melamine  
Color  
City Oak  
Doors  
Slab Uppers  
Slab Loweres  
Drawer Fronts  
Slab Shallow  
Slab Deep

Slab Upper & Lower Doors

Available for Full Access Cabinetry

## Velluto

Slab

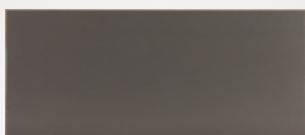

Laminate  
Ultra Matte  
Melamine  
Color  
Antracita  
Doors  
Slab Uppers  
Slab Loweres  
Drawer Fronts  
Slab Shallow  
Slab Deep

Slab Upper & Lower Doors

Available for Full Access Cabinetry

## Yosemite textured colors available

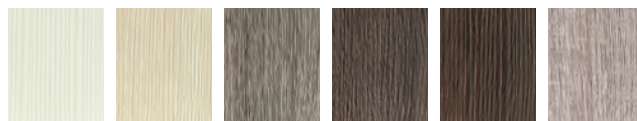

Bianco Oregon Pine City Oak Aspen Oak Carbone Barn Oak

## Elegante high gloss colors available



Bianco Antracita Euroline 03

## Velluto ultra matte colors available



Antracita Black

# Framed Cabinet Boxes

## The Basics Box

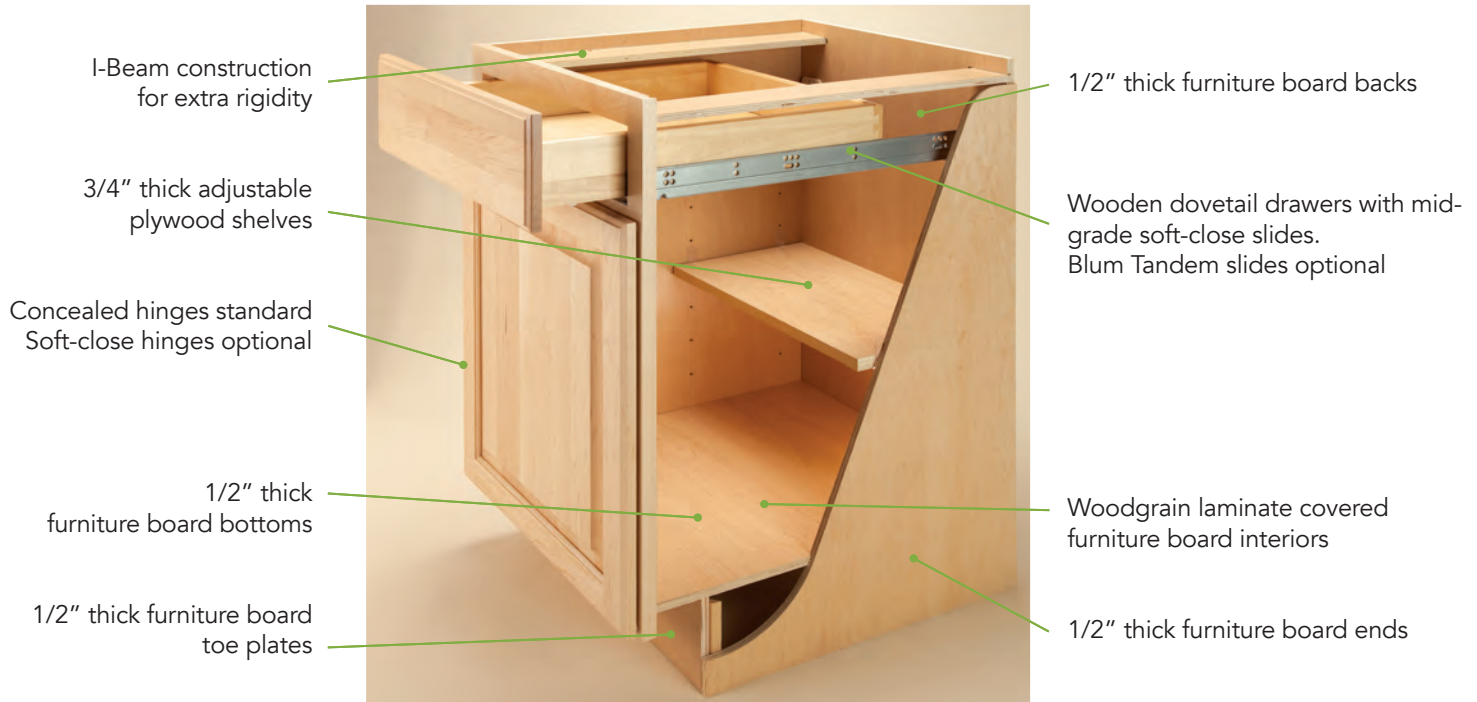

## The Standard Box

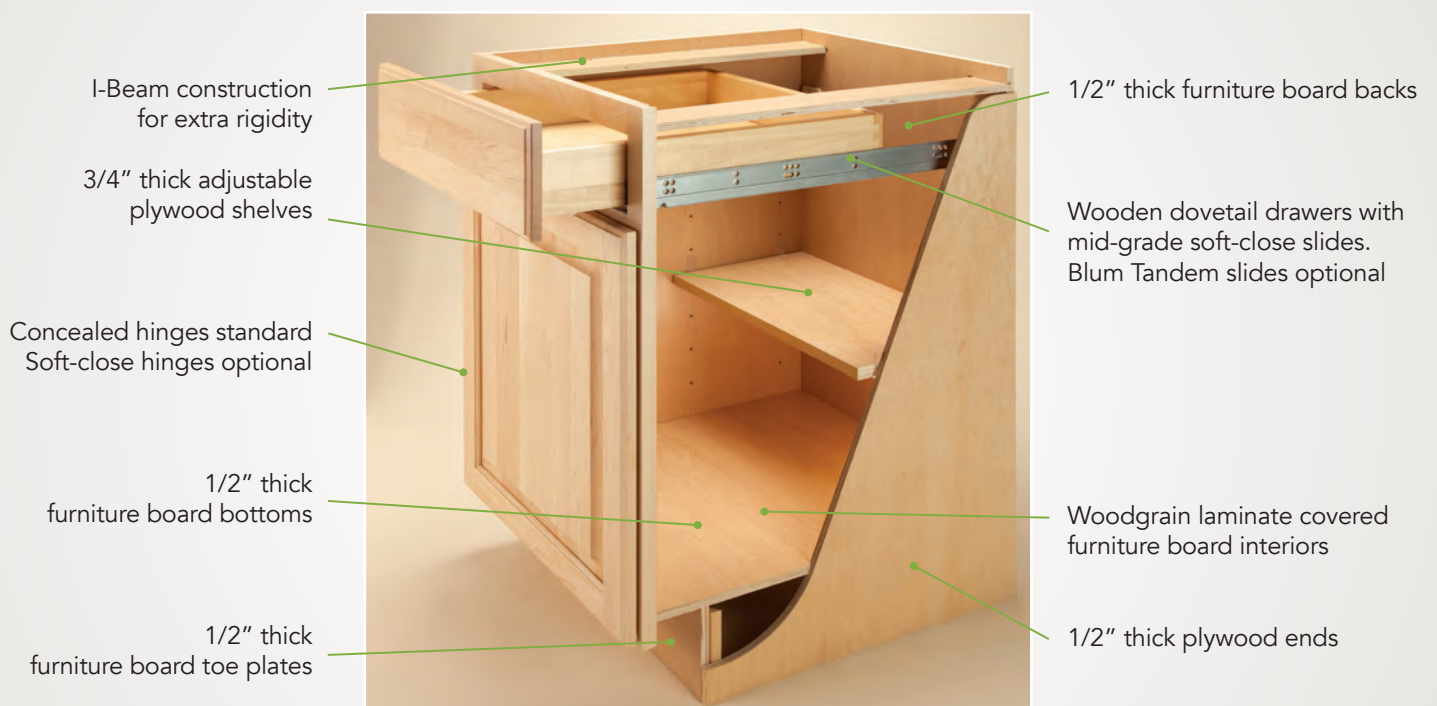

# Framed Cabinet Boxes

## The Deluxe Box

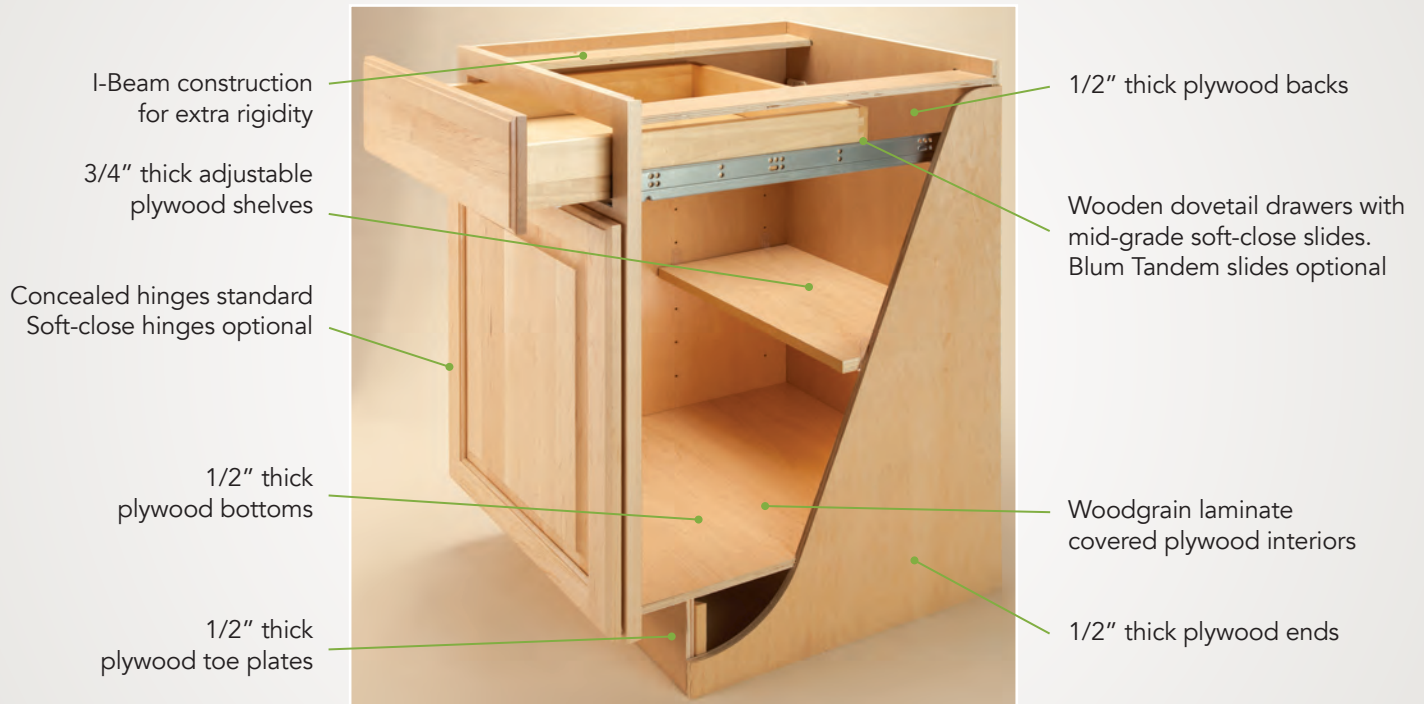

## The Ultimate Box



# Framed Cabinet Boxes

## The Paint Box

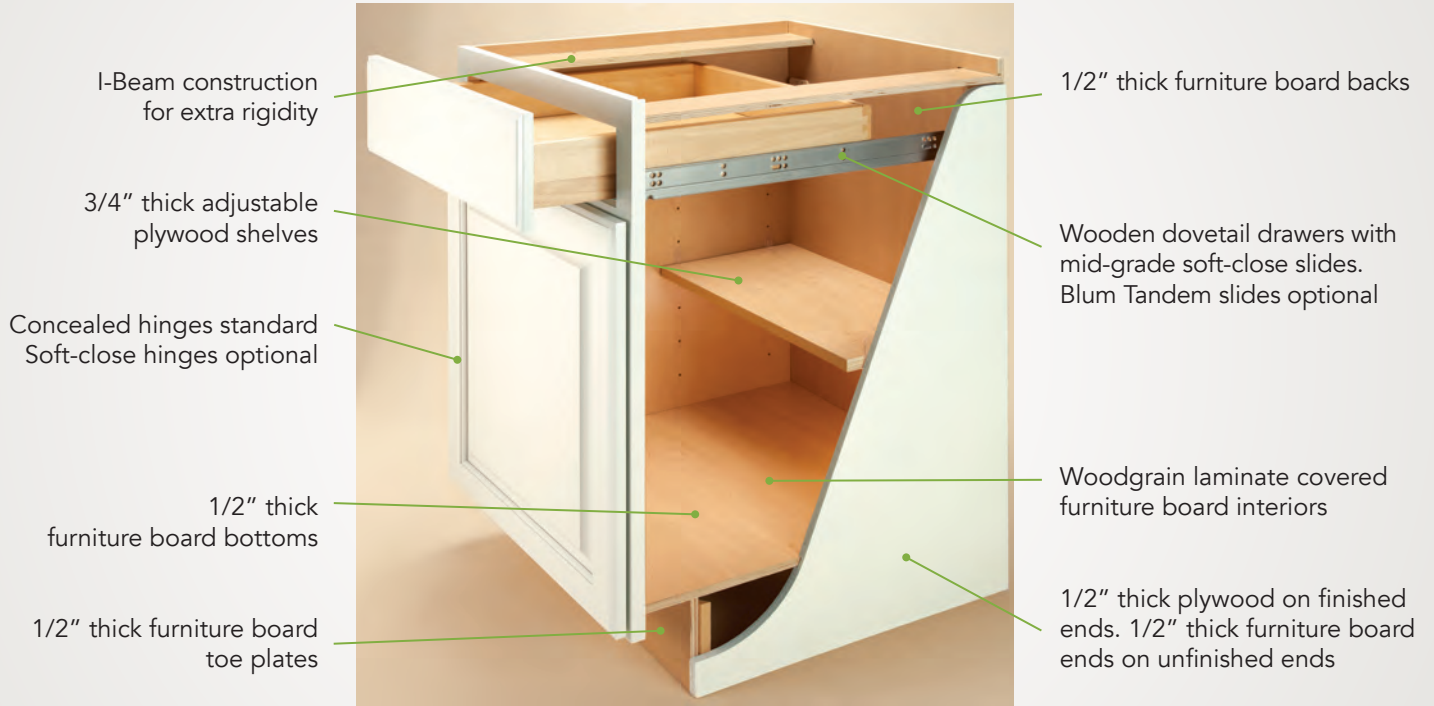

## Drawer Options

Good



Dovetailed Wood Drawer Box  
Soft-close mid-grade slides

Better



Dovetailed Wood Drawer Box  
Blum Tandem full extension  
Soft-close slides



# Full Access Cabinet Boxes

## The Woodgrain Box

3/4" thick furniture board stretchers in base and vanity cabinets

3/4" thick adjustable plywood shelves

Soft-close hinges

3/4" thick furniture board bottoms

3/4" thick furniture board toe plates

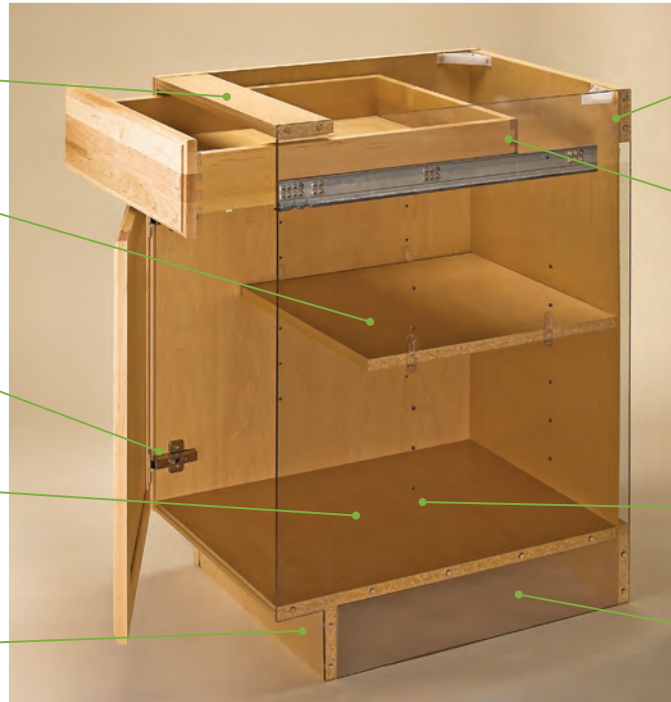

3/4" thick furniture board hanging rails and captive MDF backs

Dovetail drawers with Blum soft-close slides. Blum Tandembox drawers are optional

Woodgrain laminate covered furniture board interiors

3/4" thick furniture board ends

## The White Box

3/4" thick furniture board stretchers in base and vanity cabinets

3/4" thick adjustable furniture board shelves

Soft-close hinges

3/4" thick furniture board bottoms

3/4" thick furniture board toe plates



3/4" thick furniture board hanging rails and captive MDF backs

Dovetail drawers with Blum soft-close slides. Blum Tandembox drawers are optional

White laminate covered furniture board interiors

3/4" thick furniture board ends

# Full Access Cabinet Boxes

## The Deluxe Box

3/4" thick plywood stretchers in base and vanity cabinets

3/4" thick adjustable plywood shelves

Soft-close hinges

3/4" thick plywood bottoms

3/4" thick plywood toe plates

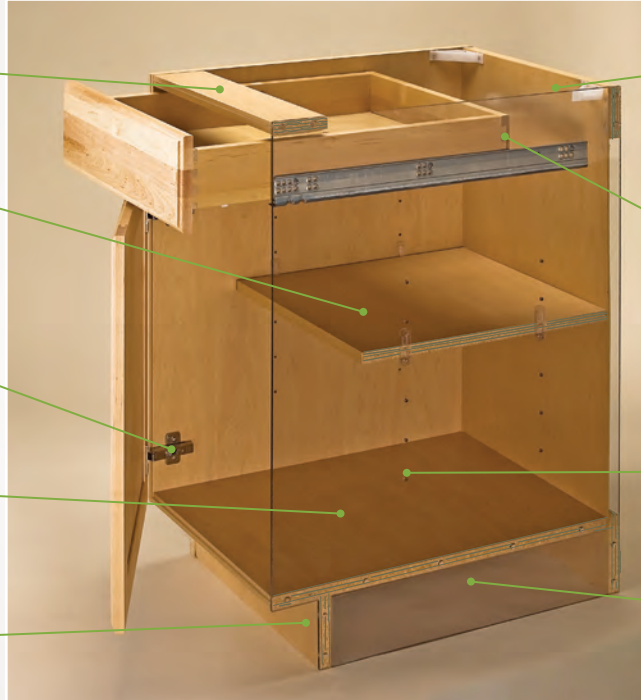

3/4" thick plywood hanging rails and captive plywood backs

Dovetail drawers with Blum soft-close slides. Blum Tandembox drawers are optional

Woodgrain laminate interiors

3/4" thick plywood ends

## The Ultimate Box

3/4" thick plywood stretchers in base and vanity cabinets

3/4" thick adjustable plywood shelves

Soft-close concealed hinges standard for most cabinets

3/4" thick plywood bottoms

3/4" thick plywood toe plates

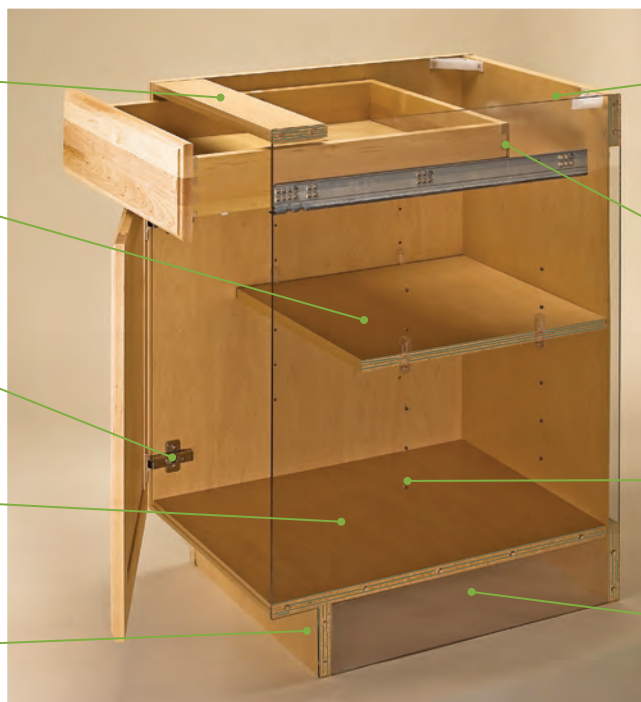

3/4" thick plywood hanging rails and captive plywood backs

Dovetail drawers with Blum soft-close slides. Blum Tandembox drawers are optional

Real wood veneer furniture interiors with a UV clear coat

3/4" thick plywood ends

# Full Access Drawer Options



Wood Dovetail Drawers and Tandem with Blumotion Drawer Slides



Blum Tandembox with Blumotion



*Ashevile door style with Natural finish. Image compliments of Adams Interiors.*



*Soho door style with Espresso stain*



**BISHOP CABINETS**

5640 Bell Rd  
Montgomery, AL 36116  
[www.bishopcabinets.com](http://www.bishopcabinets.com)  
800.410.2444  
MADE IN THE USA

Your local Bishop dealer is:



*Because printed media cannot accurately portray colors, tones and textures, a physical sample of the exact specie (where applicable), door style and color should be seen before making a final decision. Specifications noted herein are subject to change without notice.*